



## testo 890 · Thermal imager



Instruction manual



---

# 1 Contents

<b>1</b>	<b>Contents .....</b>	<b>3</b>
<b>2</b>	<b>Safety and the environment .....</b>	<b>5</b>
2.1.	About this document .....	5
2.2.	Ensure safety .....	6
2.3.	Protecting the environment .....	7
<b>3</b>	<b>Specifications .....</b>	<b>8</b>
3.1.	Use .....	8
3.2.	Technical data .....	9
<b>4</b>	<b>Product description .....</b>	<b>20</b>
4.1.	Overview .....	20
4.1.1.	Product components .....	20
4.1.2.	Display interface .....	22
4.1.3.	Operating concept .....	24
4.2.	Basic properties .....	25
4.2.1.	Power supply .....	25
4.2.2.	File formats and file names .....	26
<b>5</b>	<b>First steps .....</b>	<b>27</b>
5.1.	Commissioning .....	27
5.1.1.	Connecting the rechargeable battery .....	27
5.1.2.	Performing basic settings .....	27
5.1.3.	Initial charging of the rechargeable battery .....	29
5.2.	Getting to know the product .....	30
5.2.1.	Adjusting the hand strap .....	30
5.2.2.	Attaching the lens cover to the hand strap .....	31
5.2.3.	Rotating the handle .....	31
5.2.4.	Attaching a shoulder strap .....	32
5.2.5.	Using a lens case .....	32
5.2.6.	Inserting the memory card .....	33
5.2.7.	Fitting/removing IR protection glass .....	33
5.2.8.	Changing the lens .....	34
5.2.9.	Switching the imager on/off .....	35
5.2.10.	Manually focusing the image .....	35
5.2.11.	Automatically focusing the image .....	36
5.2.12.	Recording (freezing/saving) an image .....	36

<b>6</b>	<b>Using the product</b> .....	<b>37</b>
6.1.	Menu bar/tabs.....	37
6.1.1.	 Analysis functions tab.....	37
6.1.2.	 Scale and correction functions tab .....	37
6.1.3.	 Main menu tab.....	38
6.2.	Menu functions.....	40
6.2.1.	Measurement.....	40
6.2.2.	Display options.....	51
6.2.3.	Image gallery.....	52
6.2.4.	Wizards .....	55
6.2.5.	Configuration .....	65
6.2.6.	Audio.....	72
6.3.	Measuring.....	74
<b>7</b>	<b>Maintaining the product</b> .....	<b>75</b>
<b>8</b>	<b>Tips and assistance</b> .....	<b>76</b>
8.1.	Questions and answers.....	76
8.2.	Accessories and spare parts.....	77

## 2 Safety and the environment

### 2.1. About this document

#### Use

- > Please read this documentation through carefully and familiarize yourself with the product before putting it to use. Pay particular attention to the safety instructions and warning advice in order to prevent injuries and damage to the products.
- > Keep this document to hand so that you can refer to it when necessary.
- > Hand this documentation on to any subsequent users of the product.

#### Warnings

Always pay attention to information that is marked by the following warnings with warning pictograms. Implement the specified precautionary measures.

Representation	Explanation
 <b>CAUTION</b>	indicates potential minor injuries
<b>NOTICE</b>	indicates circumstances that may lead to damage to the products

#### Symbols and writing standards

Representation	Explanation
<b>i</b>	Note: Basic or further information.
1. ... 2. ...	Action: more steps, the sequence must be followed.
> ...	Action: a step or an optional step.
- ...	Result of an action.
<b>Menu</b>	Elements of the instrument, the instrument displays or the program interface.

[OK]	Control keys of the instrument or buttons of the program interface.
...   ...	Functions/paths within a menu.
“...”	Example entries

## 2.2. Ensure safety

- > Only operate the product properly, for its intended purpose and within the parameters specified in the technical data. Do not use any force.
- > Do not operate the instrument if there are signs of damage at the housing, mains unit or feed lines.

During operation, the imager must not be pointed at the sun or other intensive sources of radiation (e.g. objects with temperatures greater than 550°C/1022°F, if using the high-temperature measurement range 1400°C/2552°F). This can lead to serious damage to the detector. The manufacturer assumes no liability for any such damage to the microbolometer detector.

- > Dangers may also arise from the systems being measured or the measuring environment: Note the safety regulations valid in your area when performing the measurements.
- > Do not store the product together with solvents. Do not use any desiccants.
- > Carry out only the maintenance and repair work on this instrument that is described in the documentation. Follow the prescribed steps exactly. Use only original spare parts from Testo.
- > Improper use of rechargeable batteries can lead to destruction or injuries by means of current surges, fire or escaping chemicals. The following instructions must be observed to avoid such hazards:
  - Only use in accordance with the directions in the instruction manual.
  - Do not short, take apart or modify.
  - Do not expose to heavy impacts, water, fire or temperatures above 60 °C.
  - Do not store in the proximity of metal objects.
  - Do not use leaky or damaged rechargeable batteries. In the event of contact with battery acid: Thoroughly wash affected area with water and consult a doctor, if necessary.

- Only charge in the instrument or the recommended charging station.
- Immediately stop the charging process if this is not completed in the given time.
- In the event of improper function or signs of overheating, immediately remove the rechargeable battery from the measuring instrument/charging station. Caution: Rechargeable battery may be hot!

## 2.3. Protecting the environment

- > Dispose of faulty rechargeable batteries/spent batteries in accordance with the valid legal specifications.
- > At the end of its useful life, send the product to the separate collection for electric and electronic devices (observe local regulations) or return the product to Testo for disposal.



■ WEEE Reg. Nr. DE 75334352

## 3 Specifications

### 3.1. Use

The testo 890 is a handy and robust thermal imager. It enables you to carry out contactless determination and display of the temperature distribution on surfaces.

Typical areas of application are:

- Building inspection: energetic assessment of buildings, and inspection of heating, ventilation and air conditioning systems.
- Preventative maintenance (servicing): mechanical and electrical inspection of systems, machines and energy distribution systems
- Production monitoring (quality assurance): monitoring of production processes
- Professional energy consultation, leak detection
- Checking of photovoltaic modules
- additional/different functions/features: telephoto lens (optional), super-telephoto lens (optional), 25° lenses (optional), display of surface moisture distribution via manual input of the ambient conditions (optional: humidity measurement in real time with radio humidity probe), SiteRecognition (site recognition with image management), voice recording, high temperature measurement (optional), process analysis package - sequence capturing in the camera and video measurement on the PC (optional)

#### **Export control**

Thermal imagers may be subject to the export restrictions of the European Union.

Please observe the national regulations for export control when exporting.



## 3.2. Technical data

### Infrared image output

Feature	Values
Detector type	FPA 640 x 480 pixels, a.Si
Thermal sensitivity (NETD)	< 40 mK at 30°C (86°F)
Field of vision/min. focusing distance	42° x 32°/0.1 m (0.33 ft) Telephoto lens (optional): 15° x 11°/0.5 m (1.64 ft) Super-telephoto lens (optional): 6,6° x 5° / 2 m (6.5 ft) 25° lens (optional) 25° x 19° / 0,2 m (0,66 ft)
Geometric resolution (IFOV)	1.13 mrad (standard lens) 0.42 mrad (telephoto lens) 0.18 mrad (super-telephoto lens) 0,68 mrad (25° lens)
Super-resolution (pixels/IFOV)	1280 x 960 pixels / 0.71 mrad (standard lens) 0.26 mrad (telephoto lens) 0.11 mrad (super-telephoto lens) 0,43 mrad (25° lens)
Image refresh rate	33 Hz within EU, 9 Hz outside of EU
Focus	Automatic/manual
Spectral range	7.5...14 µm

### Visual image output

Feature	Values
Image size	3.1 megapixels
Min. focusing distance	0.5 m (1.64 ft.)

**Image presentation**

<b>Feature</b>	<b>Values</b>
Image display	LCD touchscreen, 10.9 cm (4.3") screen diagonal, 480 x 272 pixels
Digital zoom	1-3x
Display options	IR image/real image
Video output	USB 2.0
Video stream	Max. 25 Hz within EU, max. 9 Hz outside EU
Colour palettes	10

**Measurement**

<b>Feature</b>	<b>Values</b>
Temperature ranges (can be changed)	<p>Measuring range 1, instruments up to serial number 2862504 (see type plate): -20 to 100 °C (-4 to 212 °F)</p> <p>Measuring range 1, instruments from serial number 2862505 (see type plate): -30 to 100 °C (-22 to 212 °F)</p> <p>Measuring range 2: 0 to 350 °C (32 to 662 °F)</p> <ul style="list-style-type: none"> <li>• Without high temperature measuring range up to 1200 °C (2192 °F)</li> </ul> <p>Measuring range 3: 0 to 650 °C (32 to 1202 °F)</p> <ul style="list-style-type: none"> <li>• With high temperature measuring range of 350 to 1200 °C (662 to 2192 °F)</li> </ul> <p>Measuring range 3: 350 to 1200 °C (662 to 2192 °F)</p> <p>Measuring range 4: 0 to 650 °C (32 to 1202 °F)</p>
	<p><b>i</b> FeverDetection (X7) measuring range</p> <p>measuring range 1: -30...100°C (-22...212°F)</p> <p>measuring range 2: 0...350°C (32...662°F)</p>

Feature	Values
Accuracy	<p>Measuring range 1 @ -20 to 100 °C (-4 to 212 °F): <math>\pm 2</math> °C (<math>\pm 3.6</math> °F)</p> <p>Measuring range 1 @ -30 to -21 °C (-22 to -5 °F), instruments from serial number 2862505 (see type plate): <math>\pm 3</math> °C (<math>\pm 5.4</math> °F)</p> <p>Measuring range 2:  <math>\pm 2</math> °C (<math>\pm 3.6</math> °F) or <math>\pm 2</math> % of m.v. (higher value applies)</p> <ul style="list-style-type: none"> <li>• Without high temperature measuring range up to 1200 °C (2192 °F)  Measuring range 3:  <math>\pm 2</math> °C (<math>\pm 3.6</math> °F) typically 0 to 100 °C (32 to 212 °F) or <math>\pm 2</math>% of m.v.</li> <li>• With high temperature measuring range of 350 to 1200 °C (662 to 2192 °F)  Measuring range 3:  <math>\pm 3</math> % of m.v.  Measuring range 4  <math>\pm 2</math> °C (<math>\pm 3.6</math> °F) typically 0 to 100 °C (32 to 212 °F) or <math>\pm 2</math>% of m.v.</li> </ul> <p>Information valid for values within the specified measuring range + tolerance</p>
Extended display range	<p>Values with no guarantee of accuracy, prefixed with a tilde (~) on the display. Only for instruments from serial number 2862505 (see type plate):</p> <p>Measuring range 1:  -50 to -33 °C (-58 to -27.4 °F)</p> <p>Measuring range 2:  -10 to -2 °C (14 to 28.4 °F)</p> <ul style="list-style-type: none"> <li>• Without high temperature measuring range up to 1200 °C (2192 °F)  Measuring range 3:  -10 to -2 °C (14 to 28.4 °F)</li> <li>• With high temperature measuring range of 350 to 1200 °C (662 to 2192 °F)  Measuring range 3:  0 to 343 °C (32 to 649.4 °F)  Measuring range 4:  -10 to -2 °C (14 to 28.4 °F)</li> </ul>
Reproducibility	$\pm 1$ °C ( $\pm 1.8$ °F) or $\pm 1$ % (higher value applies)

<b>Feature</b>	<b>Values</b>
Emissivity/reflected temperature settings	0.01 to 1.00
Reflected temperature/transmission correction (atmosphere) settings	Manual
Minimum measuring point diameter	Standard lens: 3.4 mm at 1 m (3.24 ft.) distance Telephoto lens: 1.3 mm at 1 m (3.24 ft.) distance Super-telephoto lens: 1.1 mm at 2 m (6.5 ft.) distance 25° lens: 4.1 mm at 1 m (3.24 ft.) distance

**Measurement**

<b>Feature</b>	<b>Values</b>
Display of surface moisture distribution	via manual input
Humidity measurement with radio humidity probe (not available in all countries)	optional: automatic measurement value transfer in real time
Solar mode	Yes
Analysis functions	Up to 10 measuring points, hot/cold spot detection, area measurement (min/max/average value), isotherm, alarm values, up to 5 range selections
ambient temperature internal sensor	-15 to +50 ° C

**Imager equipment**

<b>Feature</b>	<b>Values</b>
Digital imager	Yes
Standard lens	42° x 32°

<b>Feature</b>	<b>Values</b>
Telephoto lens	Optional: 15° x 11°
Super-telephoto lens	Optional: 6,6° x 5°
25° lens	Optional: 25° x 19°
Image stitching wizard	Yes
Laser (not available in Japan)	635 nm, Class 2
Voice recording	via Bluetooth (not available in all countries)/via wired headset
Video measurement (via USB)	Up to 3 measuring points
Full radiometric video measurement (via USB)	(optional)
Acoustic alarm	yes

### Image storage

<b>Feature</b>	<b>Values</b>
File format	.bmt, possible export to .bmp, .jpg, .png, .csv, .xls
Video file format (via USB)	.wmv, .mpeg-1, vmt (full radiometric video, testo format)
Storage device	SD card 2 GB (800 to 1000 images)

### Power supply

<b>Feature</b>	<b>Values</b>
Battery type	Fast-charging Li-ion battery can be changed on site
Operating time	Approx. 4.5 h at 20 to 30°C (68 to 86°F)
Charging option	In instrument/in charging station (optional)
Mains operation	Yes, with mains unit 0554 8808
Mains unit output voltage	5 V / 4 A

#### Ambient conditions

Feature	Values
Operating temperature range	-15 to 50°C (5 to 122°F)
Storage temperature range	-30 to 60°C (-22 to 140°F)
Air humidity	20 to 80% non-condensing

#### Physical features

Feature	Values
Weight	1630 g (including battery)
Dimensions (L x W x H)	253 x 132 x 111 mm (0.83 x 0.44 x 0.37")
Tripod mounting	1/4" - 20 UNC
Housing protection class (IEC 60529)	IP54
Vibration (IEC 60068-2-6)	2G





#### Bluetooth (not available in all countries)

#### Approval and Certification

Product	testo 890
Mat.-No.	0563 0890
Date	21.01.2019

**i** The use of the wireless module is subject to the regulations and stipulations of the respective country of use, and the module may only be used in countries for which a country certification has been granted. The user and every owner has the obligation to adhere to these regulations and prerequisites for use, and acknowledges that the re-sale,

export, import etc. in particular in countries without wireless permits, is his responsibility.

Country	Comments	
Australia		E 1561
Canada	contains IC 5123A-WT11U  See IC Warnings	
Europa + EFTA	   The EU Declaration of Conformity can be found on the testo homepage <a href="http://www.testo.com">www.testo.com</a> under the product specific downloads.  <b>EU countries:</b> Belgium (BE), Bulgaria (BG), Denmark (DK), Germany (DE), Estonia (EE), Finland (FI), France (FR), Greece (GR), Ireland (IE), Italy (IT), Latvia (LV), Lithuania (LT), Luxembourg (LU), Malta (MT), Netherlands (NL), Austria (AT), Poland (PL), Portugal (PT), Romania (RO), Sweden (SE), Slovakia (SK), Slovenia (SI), Spain (ES), Czech Republic (CZ), Hungary (HU), United Kingdom (GB), Republic of Cyprus (CY).  <b>EFTA countries:</b> Iceland, Liechtenstein, Norway, Switzerland	
Japan	  <b>209- J00232</b>  See Japan Information	



Turkey	Authorized																
USA	 <p>contains FCC ID: QQQWT11U</p> <p>See FCC Warnings</p>																
Radio module	<table border="1"> <thead> <tr> <th>Feature</th> <th>Values</th> </tr> </thead> <tbody> <tr> <td>Bluetooth Range</td> <td>&lt;10 m (free field)</td> </tr> <tr> <td>Bluetooth type</td> <td>Bluegiga WTT11u Bluetooth Module</td> </tr> <tr> <td>Declaration ID</td> <td>D031190</td> </tr> <tr> <td>Bluetooth radio class</td> <td>Class 1</td> </tr> <tr> <td>Bluetooth company</td> <td>Silicon Laboratories Inc.</td> </tr> <tr> <td>RF Band</td> <td>2402 - 2480 MHz</td> </tr> <tr> <td>Nominal output power</td> <td>17 dBm</td> </tr> </tbody> </table>	Feature	Values	Bluetooth Range	<10 m (free field)	Bluetooth type	Bluegiga WTT11u Bluetooth Module	Declaration ID	D031190	Bluetooth radio class	Class 1	Bluetooth company	Silicon Laboratories Inc.	RF Band	2402 - 2480 MHz	Nominal output power	17 dBm
Feature	Values																
Bluetooth Range	<10 m (free field)																
Bluetooth type	Bluegiga WTT11u Bluetooth Module																
Declaration ID	D031190																
Bluetooth radio class	Class 1																
Bluetooth company	Silicon Laboratories Inc.																
RF Band	2402 - 2480 MHz																
Nominal output power	17 dBm																

## IC Warnings

### RSS-Gen & RSS-247 statement:

This device complies with Industry Canada licence-exempt RSS standard(s).

Operation is subject to the following two conditions:

(1) this device may not cause interference, and

### 3 Specifications

---

(2) this device must accept any interference, including interference that may cause undesired operation of the device.

Le présent appareil est conforme aux CNR d'Industrie Canada applicables aux appareils radio exempts de licence.

L'exploitation est autorisée aux deux conditions suivantes :

- (1) l'appareil ne doit pas produire de brouillage, et
- (2) l'utilisateur de l'appareil doit accepter tout brouillage radioélectrique subi, même si le brouillage est susceptible d'en compromettre le fonctionnement.

Caution: Radio Frequency Radiation Exposure

This equipment complies with IC radiation exposure limits set forth for an uncontrolled environment and meets the IC radio frequency (RF) Exposure Guidelines. This equipment should be installed and operated keeping the radiator at least 20 cm or more away from person's body in normal use position.

Co-Location:

This transmitter must not be co-located or operated in conjunction with any other antenna or transmitter.

Attention : exposition au rayonnement de radiofréquences

Cet équipement est conforme aux limites d'exposition aux radiofréquences IC fixées pour un environnement non contrôlé et aux Lignes directrices relatives à l'exposition aux radiofréquences (RF). Cet équipement devrait être installé et utilisé à une distance d'au moins 20 cm d'un radiateur ou à une distance plus grande du corps humain en position normale d'utilisation.

Co-location

Ce transmetteur ne peut pas être installé en colocation ou être utilisé avec une autre antenne ou transmetteur, quel qu'en soit le type.

### FCC Warnings

Information from the FCC (Federal Communications Commission)

#### **For your own safety**

Shielded cables should be used for a composite interface. This is to ensure continued protection against radio frequency interference.

#### **FCC warning statement**

This equipment has been tested and found to comply with the limits for a Class B digital device, pursuant to Part 15 of the FCC Rules. These limits are designed to provide reasonable protection against harmful interference in a residential installation. This equipment generates, uses and can radiate radio frequency energy and, if not installed and used in accordance with the instructions, may cause harmful interference to radio communications. However, there is no guarantee that interference will not occur in a particular installation. If this equipment does cause harmful interference to radio or television reception, which can be determined by turning the equipment

off and on, the user is encouraged to try to correct the interference by one or more of the following measures:

- Reorient or relocate the receiving antenna.
- Increase the separation between the equipment and receiver.
- Connect the equipment into an outlet on a circuit different from that to which the receiver is connected.
- Consult the dealer or an experienced radio/TV technician for help.

### **Caution**

Changes or modifications not expressly approved by the party responsible for compliance could void the user's authority to operate the equipment. Shielded interface cable must be used in order to comply with the emission limits.

### **Warning**

This device complies with Part 15 of the FCC Rules.

Operation is subject to the following two conditions:

- (1) this device may not cause harmful interference, and
- (2) this device must accept any interference received,

including interference that may cause undesired operation.

### **Caution: Radio Frequency Radiation Exposure**

This equipment complies with FCC radiation exposure limits set forth for an uncontrolled environment and meets the FCC radio frequency (RF) Exposure Guidelines. This equipment should be installed and operated keeping the radiator at least 20 cm or more away from person's body in normal use position.

## Japan Information

当該機器には電波法に基づく、技術基準適合証明等を受けた特定無線設備を装着している。

## 4 Product description

### 4.1. Overview

#### 4.1.1. Product components



- 1 Digital imager lens for taking visual images and two power -LEDs for illuminating the image.
- 2 Infrared imager lens for taking thermograms.
- 3 **[Release lens]** for releasing the lens lock.
- 4 Thread (1/4" - 20 UNC) for attaching a tripod (bottom of imager). Do not use desktop tripods: danger of tipping over!
- 5 Laser (not available in all countries) for marking the measurement object.



When using the super-telephoto lens the laser for marking the measure object is not available.



#### CAUTION



**Laser radiation! Class 2 laser**

> Do not look into the beam.







6 **Focusing ring** for adjusting the focus manually.**CAUTION****Auto mechanism may be damaged!**

> Only turn **focusing ring** when auto-focus is deactivated (.

7 Rotatable handle with adjustable hand strap and fastening loop for the lens cover.

8 Battery compartment (bottom of imager).

9 Operating buttons (back and top of imager):

Button	Functions
	Switch imager on/off
 (5-way joystick)	Press  : open menu, activate selection/setting. Move  up/down/right/left: select functions, navigate
	Cancel action.
	Shortcut keys for activating various functions. The current shortcut key assignment is displayed (top left). For adjustable functions, see Configure key, page 69.
 (round unmarked button)	Press button (only when auto-focus is activated): focus image automatically. Press button: record image (freeze/save).

10 Two fixing eyelets for carrying/shoulder strap.

11 Interface terminals:

Terminal	Assignment
Top	Mains socket, headset socket, Battery status LED. Battery status LED indications (imager on): <ul style="list-style-type: none"> <li>• Off (no battery inserted).</li> <li>• Flashing (mains unit is connected and battery is charging).</li> <li>• On (mains unit is connected and battery is fully charged).</li> </ul>
Bottom	USB port, memory card slot, HDMI port type D



12 Display, can be flipped out 90° and rotated 270°.

**i** When the imager is switched on, the display remains active even when folded in. It is advisable to use the power-save options to prolong the battery life, see Power-save options, page 70.

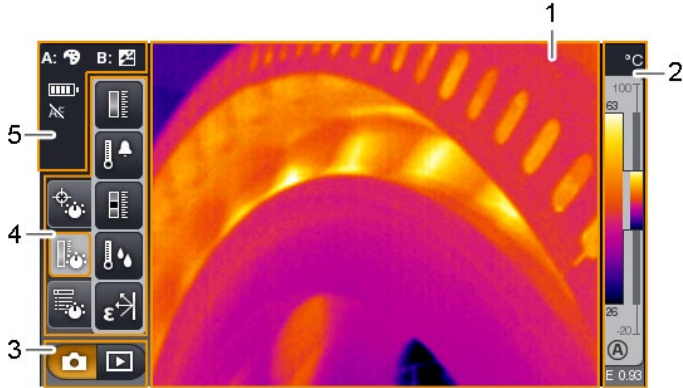
### 4.1.2. Display interface



- 1 Image display: shows IR image or real image.
- 2 Scale display:

Display	Description
<b>0</b>	<b>Protection glass</b> function activated. No symbol when function is deactivated.
°C, °F or %	Selected unit for measurement value and scale displays.
	Left: temperature margin of the image displayed, showing the minimum/maximum measurement value (with automatic scale adjustment) or the selected minimum/maximum display value (with manual scale adjustment). Right: temperature margin of the image displayed, based on the set measurement range, showing the measurement range limits.
(A) or (M)	Automatic or manual scale adjustment activated.
	Histogram adjustment activated.

Display	Description
	Set emissivity.

3 Imager mode selection bar:











 button for recording mode,  button for image gallery mode.



















4 Menu bar: the menu bar comprises 3 tabs including buttons for selecting functions:

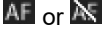

Further information is available under Menu bar/tabs, page 37.

5 Status displays:

Display	Description
<b>A:</b> , <b>B:</b>	<p>Possible shortcut key functions (to change the assignment, see Configure key, page 69):</p> <ul style="list-style-type: none"> <li>: Image type.</li> <li>: Emissivity.</li> <li>: Palette.</li> <li>: Scale.</li> <li>: Power -LEDs.</li> <li>: Laser.</li> </ul> <div style="border: 1px solid black; background-color: yellow; padding: 5px; margin: 10px 0;"> <p><b>CAUTION</b></p> <p> <b>Laser radiation! Class 2 laser</b></p> <p>&gt; Do not look into the beam.</p> </div> <ul style="list-style-type: none"> <li>: Adjustment.</li> <li>: Zoom in.</li> <li>: Zoom out.</li> <li>: Humidity</li> </ul>

	 : Solar  : Image stitching  : Site recognition When viewing a saved image in the single image view of the image gallery, the function buttons are permanently assigned the following functions:  : display previous image.  : display next image.
	Power supply/battery capacity:  : Mains operation, battery fully charged.  : Mains operation, no battery inserted.  : Battery operation, capacity 75-100%  : Battery operation, capacity 50-75%  : Battery operation, capacity 25-50%  : Battery operation, capacity 10-25%  : Battery operation, capacity 0-10%.  (animated): battery is charging.
	Auto-focus activated or deactivated.
	radio link to radio probe established.
	Bluetooth interface activated.
	headset connected.
	USB connection established.

### 4.1.3. Operating concept

The imager can be operated in two different ways.

Operation via **touchscreen** offers quick access to functions.

Operation via **joystick** requires more actions but enables single-handed operation of the imager.

#### Joystick operation

Selection and activation is carried out in two steps: moving the joystick (  ) up/down/right/left moves the orange selection box on the display. The selected function or button is activated by pressing the joystick.



### **Touchscreen operation**

Selection and activation is carried out in one step: the required function or button is selected at the touch of a fingertip and is activated at the same time.

---

**i** Capacitive touchscreen. Operation is only possible with a bare fingertip (no gloves) or a conductive stylus pen.

---

### **Illustration in this document**

To carry out the basic settings, examples of both methods of operation are given, describing all steps, see Performing basic settings, page 27.

The other chapters only deal with functions/buttons that have to be activated:

- Touchscreen operation: touch with a fingertip.
- Joystick operation: select first (move joystick up/down/right/left), then activate (press joystick).

## **4.2. Basic properties**

### **4.2.1. Power supply**

The power is supplied to the instrument via a replaceable rechargeable battery or via the mains unit provided.

With an attached mains unit, power is supplied automatically via the mains unit and the instrument's rechargeable battery is charged (only at ambient temperatures from 0 to 40°C).

---

**i** Under high ambient temperatures a longer charging time may be required.

---

Charging the battery is also possible using a desktop charging station (accessory: 0554 8851).

The instrument is equipped with a buffer battery to maintain the system data during an interruption in the power supply (e.g. when the battery is changed).

## 4.2.2. File formats and file names

All saved single images consist of an IR image and attached real image.

The images and videos are saved according to the following pattern: **XXyyyyyy.zzz**

**XX:**

- **IR** for all single images (standard)
- **ST** for a package consisting of multiple single images (recorded using the panorama image assistant)
- **SQ** sequence in VMT format (recorded using the Sequence Capturing assistant)
- **AA, AB**, etc., **AZ, BA, BB**, etc.: Single image of a sequence in BMT format (recorded using the sequence capturing assistant).

**yyyyyy:**

- 6-digit consecutive number.

**zzz:**

- **bmt** for all images (Testo-specific file extension)
- **vmt** for all videos (Testo-specific file extension).

## 5 First steps

### 5.1. Commissioning

#### 5.1.1. Connecting the rechargeable battery

1. Open battery compartment cover (1).
2. Slide rechargeable battery (2) fully into the battery compartment until it clicks into place.

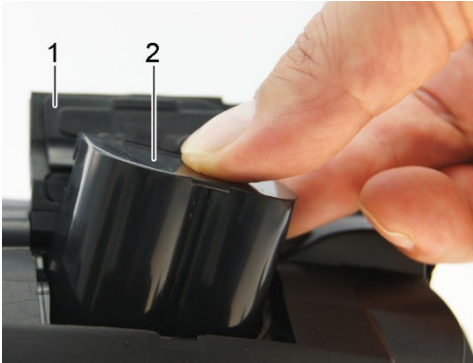



- The imager starts automatically.
3. Close the battery compartment cover.













#### 5.1.2. Performing basic settings

- > Flip open the display and remove the protective film.
- The start screen appears on the display.
- When you first switch on the imager: the **Country settings** and **Set time/date** dialogue boxes are opened one after the other to set the instrument language, temperature unit (°C/°F) and time/date.













##### Touchscreen operation





- ✓ The **Country settings** dialogue box is opened.

1. Touch the required language. If necessary, scroll with  /  to display other languages.
- The activated language is indicated with a tick.

2. Touch  to change the unit.
    - The activated unit is shown on the top right of the display.
  3. Touch  to confirm the entry.
    - The **Set time/date** dialogue box is opened.
  4. Touch the top button  to open the **Time** input screen.
  5. Set values for **Hour** and **Minute** with  / .
  6. Touch  to confirm the entry.
  7. Touch the bottom button  to open the **Date** input screen.
  8. Set values for **Day**, **Month** and **Year** with  / .
  9. Touch  to confirm the entry.
  10. Touch  to close the input screen.
- > Hold down  to close the imager.

### Joystick operation

- ✓ The **Country settings** dialogue box is opened.
1. Move  up/down to select the required language.
    - An orange box appears around the selected language.
  2. Press  to activate the selection.
    - The activated language is indicated with a tick.
  3. Move  left/up to select .
  4. Press  to change the unit.
    - The activated unit is shown on the top right of the display.
  5. Move  down to select .
  6. Press  to activate the selection.
    - The **Set time/date** dialogue box is opened.
  - The top button  is selected.
  7. Press  to open the **Time** input screen.
  8. Move  up/down to set the values for **Hour** and **Minute**. To toggle between the parameters, move  left/right.

9. Move [•] left to select .
  10. Press [•] to activate the selection and close the input screen.
  11. Move [•] down to select the bottom button .
  12. Press [•] to open the **Date** input screen.
  13. Move [•] up/down to set the values for **Day**, **Month** and **Year**.  
To toggle between the parameters, move [•] left/right.
  14. Move [•] left to select .
  15. Press [•] to activate the selection and close the input screen.
  16. Move [•] left to select .
  17. Press [•] to activate the selection and close the input screen.
- > Hold down  to close the imager.

### 5.1.3. Initial charging of the rechargeable battery

The imager is delivered with a partially charged battery. Fully charge the battery before use.

- > Connect the country-specific adapter required for the existing mains to the mains unit.

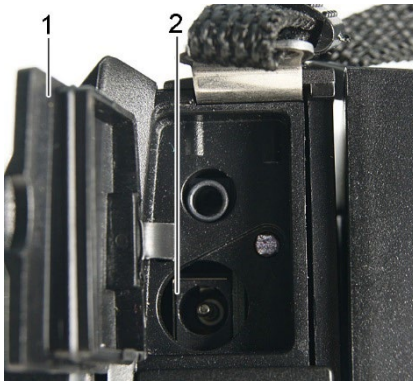

1. Open the cover of the top interface terminal (1).
  2. Connect the mains unit to the mains socket (2).
  3. Connect the mains plug to a power socket.
- The imager starts automatically.

---

**i** The rechargeable battery can be recharged with the imager switched on or off. This has no effect on the time required to charge the battery.

---

- Charging of the battery is started.
  - The charge status is indicated by the status LED (3):
    - LED flashes: charging in process.
    - LED lights: battery charged, charging process finished.
  - 4. Fully charge the battery, then disconnect the instrument from the mains unit.
    - After initial charging of the battery, the imager is ready for use.
- A desktop charging station (accessory: 0554 8851) can also be used to charge the battery.

## 5.2. Getting to know the product

### 5.2.1. Adjusting the hand strap

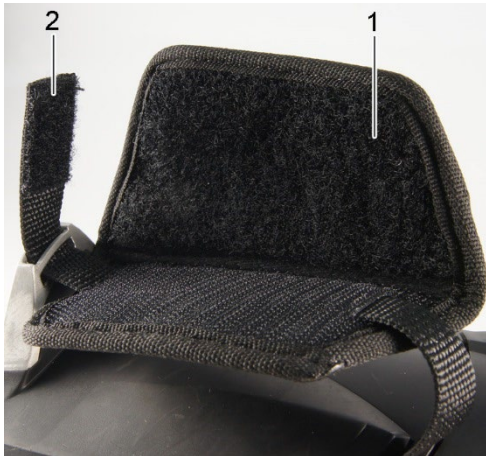

- > Lay the imager on its left side.
1. Open out the top of the hand strap padding (1).
  2. Pull the fastening end of the strap up (2).
  3. Put your right hand through the hand strap from the right-hand side.
  4. Adjust the hand strap by loosening/tightening it to fit your hand and secure the fastening end again.
  5. Fold down the top of the hand strap padding.

## 5.2.2. Attaching the lens cover to the hand strap



- > Guide the clip on the lens cover (1) through the loop on the handle (2).

## 5.2.3. Rotating the handle

The handle can be rotated up to 180° in 10 positions.



1. Put your right hand through the hand strap.
2. Grip the imager with your left hand. To do this, hold the casing at the front of the imager (1).

**CAUTION**

**Display may be damaged!**

- > Do not hold the imager by the fold-out display.

3. Turn your right hand to move the handle to the required position (2). Press down with your middle and ring finger. To rotate in the opposite direction, press up with the heel of your hand.

### 5.2.4. Attaching a shoulder strap



- > Link together shoulder strap click locks and the carrying strap attached to the imager.

### 5.2.5. Using a lens case

The lens case (included in the scope of delivery of the interchangeable lens) is used to protect and transport the interchangeable lens. It can be attached using the carabiner e.g. to a belt loop.

To protect against damage to lenses not being used, the transparent plastic cap must always be attached to the back of the lens. Make sure that the case zip is properly zipped up.



## 5.2.6. Inserting the memory card

1. Open the cover of the bottom interface terminal (1).
2. Push the memory card (SD or SDHC card) into the card slot (2).

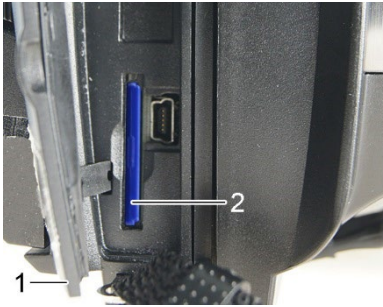

- > To remove the memory card: press the memory card to release the lock.

## 5.2.7. Fitting/removing IR protection glass

**i** It is not possible to use IR protection glass in conjunction with a super-telephoto lens.

The lens focusing ring has an internal thread for fitting the protection glass.

### Fitting

- > Insert the protection glass into the lens focusing ring and turn clockwise as far as it will go.

### Removing

- > Turn the protection glass anti-clockwise and remove it.

After fitting or removing the protection glass, activate or deactivate the **Protection glass** option, see Optics, page 70. A wrong setting of this option will happen no compensation of these deviations, which are caused by the assembly or disassembly of the lens protective glass is created. The However, specific measurement accuracy is no longer safe guaranteed.

## 5.2.8. Changing the lens

Only lenses that have been adjusted to the respective thermal imager can be used. The serial number on the lens must match the serial number displayed in the imager, see Optics, page 70.

> Place the imager on a stable base.

### Removing the lens



1. Grip the lens with your left hand (1), hold the imager with your right (2) and press **[Release lens]** (3).

2. Unscrew lens by turning it anti-clockwise and remove.

Always keep lenses in the lens case (included in the scope of delivery of the interchangeable lenses) while they are not in use.



### Attaching a new lens

1. Grip the lens with your left hand (1) and hold the imager with your right (2).

2. Line up the marks on the lens and the instrument (4) and place the lens in the lens mount.

3. Push the lens into the mount as far as it will go and turn it clockwise until it clicks into place.

## 5.2.9. Switching the imager on/off

1. Remove protection cap from the lens.
2. Press .
  - The start screen appears on the display. Instrument information is displayed (e.g. serial number, type designation, firmware version).
  - The measurement view is opened. Measurement values on the cursor and scale are only displayed when the stabilisation phase is complete (indicated by a rotating symbol in the top right of the display).
  - The imager performs automatic adjustment approx. every 60 s. This can be recognized by means of a "click". The image is frozen briefly when this occurs.
- > To switch off: Hold down  until the confirmation prompt is no longer displayed.
  - The imager is switched off.

## 5.2.10. Manually focusing the image

### CAUTION





#### Auto mechanism may be damaged!

- > Only turn **focusing ring** when auto-focus is deactivated ().

- > Deactivate auto-focus:  | .
-  is displayed.
- > Turn the lens **focusing ring** until the image is in sharp focus.

- i** For focusing, observe the appropriate minimum distance depending on the lens used:
- telephoto lens 0.5 m (1.64 ft)
  - super-telephoto lens 2 m (6.5 ft)
  - standard lens 0,1 m (0,33 ft)
  - 25° lens 0,2 m (0,66 ft)

### 5.2.11. Automatically focusing the image

- > Activate auto-focus:  | .
-  is displayed and  is highlighted orange.
- > Touch **[Trigger button]**.
- The image is automatically focussed. The area to be focussed must be inside the orange box, which is shown by touching the trigger button.

### 5.2.12. Recording (freezing/saving) an image

1. Press the **[Trigger button]**.
- The image is frozen (still).

If you want to save the image, touch  to select where you want to save it to, see Image gallery, page 52.

2. Save image: press **[Trigger button]** again or touch .
- The IR image is saved and the real image is automatically attached to the IR image.
- > Do not save image: press **[Esc]**.





## 6 Using the product

### 6.1. Menu bar/tabs

Functions are called up via the menu bar. The menu bar comprises 3 tabs. Different functions are available depending on which tab is selected.





Tabs and functions are described briefly below. Detailed information about the individual functions is given in the following chapters.

#### 6.1.1. Analysis functions tab

Button	Function	Description
	<b>New mark</b>	Insert new measuring point mark. See also Pixel mark   New mark, page 41.
	<b>Min/Max on Area</b>	Show area mark. See also Min/max/avg on area, page 42.
	<b>Hotspot</b>	Display maximum measurement value. When the function is enabled, the button is highlighted orange. See also Pixel mark   Hotspot, page 41.
	<b>Coldspot</b>	Display minimum measurement value. When the function is enabled, the button is highlighted orange. See also Pixel mark   Coldspot, page 41.
	<b>Image type</b>	Change display: toggle between IR image and real image.

#### 6.1.2. Scale and correction functions tab





Button	Function	Description
	<b>Scale</b>	Open <b>Scale manual</b> input screen. To adjust the measurement value scale. See also Scale manual, page 50.

Button	Function	Description
	<b>Alarm</b>	Open <b>Alarm</b> input screen. To set the limits and activate/deactivate the function. See also Alarm, page <b>44</b> .
	<b>Isotherm</b>	Open <b>Isotherm</b> input screen. To set the limits and activate/deactivate the function. See also Isotherm, page <b>44</b> .
	<b>Humidity</b>	Open <b>Humidity</b> input screen. To set the parameters and activate/deactivate the function. See also <b>Humidity</b> , page <b>45</b> .
	<b>Emissivity</b>	Open <b>Emissivity</b> input screen. To set the parameters. See also Emissivity, page <b>48</b> .

### 6.1.3. Main menu tab











The displayed functions on the tab differ depending on the current view.

#### View of current image

Button	Function	Description
	<b>Menu</b>	Open menu. Via the menu, most functions from the 3 tabs and many additional functions can be called up. See Measurement, page <b>40</b> .
	<b>Auto-focus</b>	Activate/deactivate auto-focus.
	<b>Zoom in</b>	To zoom in on the image (digital zoom, 5 increments).
	<b>Zoom out</b>	To zoom out of the image to the full image view.

Button	Function	Description
	<b>Site recognition</b>	To record site markers. The button is not displayed as default. It has to be re-activated every time the imager is switched on: call up the <b>SiteRecognition</b> function again from the menu and set a marker.

#### Frozen or saved image view

Button	Function	Description
	<b>Menu</b>	See above.
	<b>Save</b>	Save image. Function only available when the image is frozen.
	<b>Folder</b>	Open <b>Folder</b> input screen. To select where to save images. Function only available when the image is frozen.
	<b>Audio</b>	when connected to a headset: open <b>Audio</b> input screen, see see Audio, page 72.
	<b>Sub-level zoom</b>	Sub-level zoom with additional functions is displayed.  : menu, see above.  : zoom in, see above.  : zoom out, see above.  : display buttons for moving the zoomed image. To move, touch the buttons shown in the image.  : close sub-level zoom.
	<b>Delete image</b>	Function only available when the image is saved.

## 6.2. Menu functions

### 6.2.1. Measurement

#### Measurement range









The measurement range can be set to adapt to the respective area of application. If measurement range 3 is selected (high-temperature measurement range), the aperture in the lens is automatically reduced to protect the detector against damage.

**i** When using a super-telephoto lens, it is not possible to select the measuring range up to 1200 °C (2192 °F).

#### CAUTION

##### Detector may be damaged!





- > If measurement range 1 and 2 are set: do not point the camera at objects with temperatures exceeding 550 °C (1022 °F).
- > If measuring range up to 650 °C (1202 °F) is set: do not point the camera at objects with temperatures exceeding 650 °C (1202 °F).
- > If measuring range up to 1200 °C (2192 °F) is set: do not point the camera at objects with temperatures exceeding 1400 °C (2552 °F).

Task	Actions/description
Set the measurement range.	>       <b>Measurement</b>    or  <b>Measurement range</b>    or  or  or 
Disable/enable warning message when saving images with readings outside the measuring range.	>  <b>Over-/Underrange Warning.</b> > To disable, touch the button again







**Pixel mark | Hotspot**

Hotspot mark (crosshairs with maximum measurement value displayed) can be shown.

Task	Actions/description
Show/hide hotspot mark.	>     . or >       <b>Measurement   Pixel mark   Hotspot.</b>





**Pixel mark | Coldspot**

The coldspot mark (crosshairs with minimum measurement value displayed) can be shown.

Task	Actions/description
Show/hide coldspot mark.	>     . or >       <b>Measurement   Pixel mark   Coldspot.</b>

**Pixel mark | New mark**







Up to 10 measuring point selections (crosshairs with reading display) can be shown and freely positioned.





Task	Actions/description
Insert new mark.	>     . or >       <b>Measurement   Pixel mark   New mark.</b>

Task	Actions/description
Move crosshairs.	> Touch and drag crosshairs. Joystick operation: 1. Select crosshairs and activate by pressing the joystick. 2. Move crosshairs by moving the joystick. > To exit: Press joystick again and activate <b>Quit moving</b> in the context menu.
Hide crosshairs.	> Double-touch the crosshairs and touch <b>Hide</b> in the context menu. Joystick operation: 1. Select crosshairs and press joystick twice. 2. In the context menu, activate <b>Hide</b> .

**Min/max/avg on area**









A range selection can be shown and freely positioned. It is possible to display up to 5 marks for minimum (**min**), maximum (**max**) and average (**avg**) readings in this area.

Task	Actions/description
Show area mark.	>     .
Show more range selections	>     or >       <b>Measurement</b>   <b>Pixel mark</b>   <b>New Min/Max on Area</b>

Task	Actions/description
Move area mark.	<p>&gt; Touch and drag area mark.</p> <p>Joystick operation:</p> <ol style="list-style-type: none"> <li>1. Select area mark and activate by pressing the joystick.</li> <li>2. Move area mark by moving the joystick.</li> </ol> <p>&gt; To exit: Press joystick again and activate <b>Quit moving</b> in the context menu.</p> <p><b>i</b> All marks displayed within the range selection are moved.</p>
Change size of area mark/hide area mark.	<p>&gt; Tap range selection.</p> <p>Enlarge range selection</p> <p>&gt; Press .</p> <p>Shrink range selection</p> <p>&gt; Press  again..</p>
Hide range selection	<p>&gt; Tap range selection.</p> <p>&gt; Press .</p>
Hot spot display in the range selection	<p>&gt; Tap range selection.</p> <p>&gt; Press .</p>
Cold spot display in the range selection	<p>&gt; Tap range selection.</p> <p>&gt; Press .</p>







### Alarm



The alarm function shows all image points with measurement values that exceed the upper alarm mark or fall below the lower alarm mark in a single colour (alarm colour). To set the alarm colours, see Colour selection, page 52.

Task	Actions/description
Open <b>Alarm</b> input screen.	<ul style="list-style-type: none"> <li>&gt;    .</li> <li>or</li> <li>&gt;       <b>Measurement</b>   <b>Alarm</b>.</li> </ul>
Activate/deactivate <b>Lower alarm</b> or <b>Upper alarm</b> .	<ul style="list-style-type: none"> <li>&gt;  <b>Active</b>.</li> <li>&gt; To deactivate, touch the button again.</li> </ul>
Set alarm values.	<ul style="list-style-type: none"> <li>&gt;  , .</li> </ul>
Apply entries.	<ul style="list-style-type: none"> <li>&gt; .</li> </ul>

### Isotherm

The isotherm function shows all image points with measurement values that lie within the set limits in a single colour (isotherm colour). To set the isotherm colour, see Colour selection, page 52.









Task	Actions/description
Open <b>Isotherm</b> input screen.	<ul style="list-style-type: none"> <li>&gt;    .</li> <li>or</li> <li>&gt;       <b>Measurement</b>   <b>Isotherm</b>.</li> </ul>
Activate/deactivate isotherm display.	<ul style="list-style-type: none"> <li>&gt;  <b>Active</b>.</li> <li>&gt; To deactivate, touch the button again.</li> </ul>
Activate/deactivate acoustic alarm	<ul style="list-style-type: none"> <li>&gt;  <b>Active</b>.</li> <li>&gt; To deactivate, touch the button again.</li> </ul>

Task	Actions/description
Set lower and upper isotherm limit.	>  ,  .
Link setting for upper/lower limits.	>  .
Apply entries.	>  .

## Humidity

The ambient temperature and humidity values entered manually or measured by the optional radio humidity probe are used to calculate the relative surface moisture for each pixel. The values can be shown as a humidity image. The special colour palette indicates which areas are at risk of mould:

Colour	Surface moisture	Assessment
green	0...64%RH	non-critical
yellow/orange	65 to 80%RH	potentially critical
red	>80%RH	critical









Task	Actions/description
Open <b>Humidity</b> input screen.	>     or >       <b>Measurement</b>   <b>Humidity</b> .
Activate/deactivate humidity image display.	>  <b>Active</b> . > To deactivate, touch the button again.
Set values manually for ambient temperature ( <b>Ambient temp.</b> ) and ambient humidity ( <b>Humidity</b> ):	>  ,  .
Set up radio link to the optional radio humidity probe.	>  Further information can be found in Section 6.2.5, in the <b>Radio</b> subsection.

Task	Actions/description
Apply entries.	>  .

### Ambient temperature

The ambient temperature can be entered manually or the internal sensor is activated, which automatically measures the ambient temperature. This temperature value can also be shown on the display once you have activated **Ambient temperature display**.







	A more accurate measurement of the ambient temperature is possible with the aid of the radio probe.
---	---

Task	Actions/description
Open <b>Ambient temperature</b> input screen.	>     . or >     . <b>Measurement functions</b>   <b>Ambient temperature</b> .
Manually set the values for ambient temperature ( <b>Ambient temperature</b> ):	>  ,  .
Activate/deactivate <b>Internal sensor</b> .	>  <b>Active</b> . > To deactivate, touch the button again.
Activate/deactivate <b>Ambient temperature display</b> (only possible when the <b>Internal sensor</b> menu is activated)	>  <b>Active</b> . > To deactivate, touch the button again.

### Atmospheric correction

Measurement deviations arising due to high humidity or large distances to the object to be measured can be corrected. Correction parameters must be entered for this.

If the imager is connected to an optional radio humidity the ambient temperature and humidity are transferred automatically. For further information on connecting to a radio humidity probe, please refer to Section 6.2.5, in the **Radio** sub-section.





Task	Actions/description
Open <b>Atmospheric correction</b> input screen.	>       <b>Measurement</b>   <b>Atmospheric correction</b> .
Activate atmospheric correction.	>  <b>Active</b> . > To deactivate, touch the button again.
Manually set the values for the ambient temperature ( <b>Temperature</b> ), ambient humidity ( <b>Humidity</b> ) and distance between the imager and the object to be measured ( <b>Distance to subject</b> ).	>  ,  .
Apply entries.	>  .

### Solar

To detect and document failures in photovoltaic systems, the solar function can be selected. The sun's radiation intensity measured (with an external instrument) can be entered for documentation purposes. This value is saved with the IR- image.

If this function is activated, the entered value for the radiation intensity is displayed (top left).

Task	Actions/description
Open <b>Solar</b> input screen.	>       <b>Measurement</b>   <b>Solar</b> .

Task	Actions/description
Activate solar functions.	<ul style="list-style-type: none"> <li>&gt;  <b>Active.</b></li> <li>&gt; To deactivate, touch the button again.</li> </ul>
Manually set the value for radiation intensity (W/m <sup>2</sup> ).	<ul style="list-style-type: none"> <li>&gt;  , .</li> </ul>
Apply entries.	<ul style="list-style-type: none"> <li>&gt; .</li> </ul>

### Emissivity

You can choose between user-defined emissivity and 8 materials with set emissivity. The reflected temperature (RTC) can be set individually.

Emissivity information:

The emissivity describes the capability of a body to emit electromagnetic radiation. This is material-specific and must be adapted for correct measurement results.

Non-metals (paper, ceramic, gypsum, wood, paints and coatings), plastics and food have high emissivity, which means that the surface temperature can be easily measured using infrared.

Because of their low or non-uniform emissivity, bright metals and metal oxides only have limited suitability for infrared measurement. Highly inaccurate measurements should be expected. A remedy for this is coatings that increase emissivity, e.g. paint or emission adhesive (accessory, 0554 0051), which must be applied to the object to be measured.

The following table gives typical emissivities of important materials. These values can be used as a guide for user-defined settings.

Material (material temperature)	Emissivity
Aluminium, bright rolled (170°C)	0.04
Cotton (20°C)	0.77
Concrete (25°C)	0.93
Ice, smooth (0°C)	0.97
Iron, emery ground (20°C)	0.24
Iron with casting skin (20°C)	0.80
Iron with rolling skin (20°C)	0.77
Gypsum (20°C)	0.90









<b>Material (material temperature)</b>	<b>Emissivity</b>
Glass (90°C)	0.94
Rubber, hard (23°C)	0.94
Rubber, soft grey (23°C)	0.89
Wood (70°C)	0.94
Cork (20°C)	0.70
Radiator, black anodised (50°C)	0.98
Copper, slightly tarnished (20°C)	0.04
Copper, oxidized (130°C)	0.76
Plastics: PE, PP, PVC (20°C)	0.94
Brass, oxidized (200°C)	0.61
Paper (20°C)	0.97
Porcelain (20°C)	0.92
Black paint, matt (80°C)	0.97
Steel, heat-treated surface (200°C)	0.52
Steel, oxidized (200°C)	0.79
Clay, burnt (70°C)	0.91
Transformer paint (70°C)	0.94
Brick, mortar, plaster (20°C)	0.93

#### Reflected temperature information:

Using this offset factor, the reflection is calculated out based on the low emissivity, and the accuracy of the temperature measurement with infrared instruments is improved. In most cases, the reflected temperature is identical to the ambient air temperature. Only when objects with strong emissions and much higher temperatures (such as ovens or machines) are in proximity to the object being measured should the radiation temperature of these heat sources be determined and used (e.g. using a globe thermometer). The reflected temperature has little effect on objects with high emissivity.













Using the PC software, other materials can be imported into the instrument from an existing list.

Task	Actions/description
Open <b>Emissivity</b> input screen.	>     or >       <b>Measurement</b>   <b>Emissivity</b> .
Select material.	> Highlight the material to be used by touching on it.
Manually set the emissivity (only when <b>User defined</b> is selected) and reflected temperature ( <b>RTC</b> ).	>  ,  .
Apply entries.	>  .

### Scale manual

Manual scaling can be activated instead of automatic scaling (continuous automatic adjustment to the current min./max. values). The scale limits can be set within the activated measurement range (see section 6.2.1).

The activated mode is displayed bottom right:  manual scaling,  automatic scaling.



Task	Actions/description
Open <b>Scale manual</b> input screen.	>     or >       <b>Measurement</b>   <b>Scale manual</b> .
Activate/deactivate manual scale adjustment.	>  <b>Active</b> . > To deactivate, touch the button again.
Set scale limits.	>  ,  .
Link setting for upper/lower limits.	>  .

Task	Actions/description
Apply entries.	> 

## 6.2.2. Display options

### Palette

You can choose from 10 existing colour palettes for the IR image display.

Task	Actions/description
Open <b>Palette</b> input screen.	>       <b>Display options</b>   <b>Palette.</b>
Select palette.	> Highlight the palette to be used by touching it.
Apply entries.	> 

### Histogram adjustment

By adjusting the colour palette to the current temperature distribution, histogram adjustment particularly in the case of scenes with a large temperature scope (e.g. with high-temperature measurements) increases the contrast.







When histogram adjustment is activated, the colours within the scale are no longer distributed in a linear pattern between the minimum and maximum scale value. It is therefore difficult to draw conclusions about temperatures from colours.

Task	Actions/description
Activate/deactivate <b>Histogram adjustment.</b>	>       <b>Display options</b>   <b>Histogram adjustment.</b>

### Colour selection



The colours used for the measurement functions **Isotherm** and **Alarm** can be set.

Task	Actions/description
Open <b>Colour selection</b> input screen.	>       <b>Display options</b>   <b>Colour selection.</b>
Set required colour for <b>Isotherm, Top Alarm</b> or <b>Bottom Alarm.</b>	>  . > Activate colour to be used by touching it.
Apply entries.	>  .

### 6.2.3. Image gallery

The saved image can be viewed and analysed in the image gallery. Folders can be created for saving new images to.

It is possible to listen to and also subsequently record or edit a voice commentary. Images with a voice commentary are indicated with the following symbol: .





Task	Actions/description
Open image gallery.	>  . or >       <b>Image gallery.</b>
Close image gallery.	>  .

#### Navigation on the overview page

Task	Actions/description
Open folder.	> Double-touch the symbol for the folder to be opened.
One level up.	>  .



Task	Actions/description
Open single image view.	> Double-touch the preview image to be opened. For further information on the single image view, see below.

### Actions on the overview page

Task	Actions/description
Create a new folder.	>  > Enter folder name. > 
Delete folder or image.	1. Select folder or image by touching on it. 2.  3. Confirm deletion: 

### Navigation in the single image view









✓ The single image view must be opened: see above.

Task	Actions/description
Open main menu to activate functions.	> 
Display next or previous image.	> <b>[A]</b> or <b>[B]</b> .
Back to overview page:	>       <b>Image gallery.</b>
Close image gallery:	> <b>[Esc]</b> .

### Actions in the single image view

✓ The single image view must be opened: see above.

Task	Actions/description
Open main menu to activate functions.	> 

Task	Actions/description
Delete image.	<ul style="list-style-type: none"> <li>&gt;  .</li> <li>&gt; Confirm deletion:  .</li> </ul>
Record/edit voice commentary	<ul style="list-style-type: none"> <li>&gt;  .</li> </ul> <p>Further Information: see section <b>Audio</b>, page 72</p>
Open sub-level zoom with additional functions.	<ul style="list-style-type: none"> <li>&gt;  : menu, see above.</li> <li>&gt;  : to zoom in on the image (digital zoom, 5 increments).</li> <li>&gt;  : to zoom out of the image to the full image view.</li> <li>&gt;  : display buttons for moving the zoomed image. To move, touch the buttons shown in the image.</li> <li>&gt;  : close sub-level zoom.</li> </ul>

## 6.2.4. Wizards

### Sequence Capturing (optional)

A sequence of images can be recorded using the Sequence Capturing assistant.

**i** This function is available as an additional option (article no. 0554 8902) and must be activated before it can be used, if the option was not ordered at the same time as the imager.

Activate function (only with subsequent order):

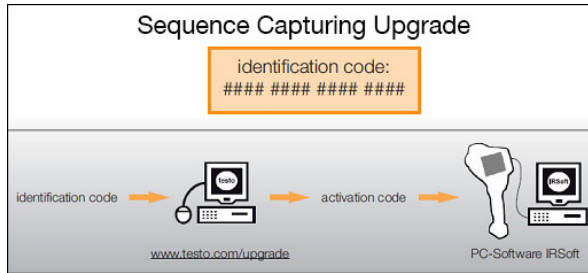

you will receive an envelope with an access code (identification code), which you should enter on the website [www.testo.com/upgrade](http://www.testo.com/upgrade).

When all necessary data has been entered, an activation code is generated and can be used to activate the function via the IRSoft PC software. Please observe the installation requirements and steps on the website or in the email sent to you.



The sequences can be saved in various formats:

- **BMT files:**  
 sequence of individual image files (thermal images), saved in a folder, folder name starts with **SQ**. Image marks placed prior to recording (measuring points and profile lines) are also saved as image data and cannot be subsequently changed or deleted.  
 The individual thermal images of the sequence can be displayed and analysed.
- **VMT files (full radiometric video):** video file in which image data, measuring values and image marks are saved, file name starts with **SQ**.  
 Saved files can be played back in testo IRSOFT and subsequently analysed over time by adding or changing image marks.  
 The playback speed (frames per second) corresponds to the video frequency of the camera, if the system environment supports this frequency (see system requirements), but max. 25 Hz.

---







If the **Humidity** and / or **SuperResolution** functions are enabled, when the sequence assistant is called up they are disabled. These functions are enabled once again when you exit the Sequence Capturing assistant.

---

Task	Actions/description
Call up function	>       <b>Assistants   Sequence Capturing.</b>



Task	Actions/description
Set recording parameters	<p>A sequence is configured using the following parameters:</p> <ul style="list-style-type: none"> <li>• <b>Format:</b> <b>VMT</b> (video file) or <b>BMT</b> without / with <b>Real image</b> (images are saved in a container folder and can be edited individually).</li> <li>• <b>Start:</b> <b>Manual</b> (when the shutter button is pressed), <b>Countdown</b> (automatic start after expiration of the set time), <b>Max. temperature &gt;</b> (automatic start following upper temperature deviation in the overall image), <b>Min. temperature &lt;</b> (automatic start following lower temperature deviation in the overall image), <b>Range: Max. temperature &gt;</b> (automatic start following upper temperature deviation within the range selection), <b>Range: Min. temperature &lt;</b> (automatic start following lower temperature deviation within the range selection).</li> </ul> <hr/> <p><b>i</b> Sequence capturing relates only to the range selection first created. This is displayed in red. Other range selections are displayed in orange.</p> <hr/> <ul style="list-style-type: none"> <li>• <b>Interval:</b> <b>Time</b> (time between the taking of two images), <b>Manual</b> (when the shutter button is pressed).</li> </ul> <hr/> <p><b>i</b> The smallest adjustable interval is 3 sec.</p> <hr/> <ul style="list-style-type: none"> <li>• <b>End:</b> Number of images.</li> </ul> <ol style="list-style-type: none"> <li>1. Touch parameter.</li> <li>- The input screen opens.</li> <li>2. Select criterion / adjust values.</li> <li>3. </li> </ol>

Task	Actions/description
Enable / disable shutter	<p>In the case of stable environmental conditions and set-ups that do not heat up the sensor / camera, the automatic shutter function can be disabled. This can prevent individual images of the sequence being recorded with a time delay (outside the programmed capturing interval). Deviations in accuracy and image quality when the shutter is disabled are negligible in a period of up to 60 minutes.</p> <p> .</p> <ul style="list-style-type: none"> <li>&gt;</li> <li>- Icon is highlighted orange: shutter is enabled.</li> <li>- Icon is not highlighted orange: shutter is disabled.</li> </ul>
Select where to save image	<p> .</p> <ul style="list-style-type: none"> <li>&gt;</li> <li>- The <b>Folder</b> input screen opens.</li> </ul>
Activate sequence	<p> .</p> <ul style="list-style-type: none"> <li>&gt;</li> <li>- A white, flashing dot (top right of the display) indicates standby status until the start of recording. When the Countdown start criterion is selected, the remaining time until the start is also displayed.</li> <li>- The recording proceeds from the start criterion entered. A red, flashing dot (top right of the display) indicates that the recording is ongoing. The number of images recorded is displayed to the left of it. The file name is displayed at the top left of the display.</li> </ul>
Show / hide configuration settings	<p>Function is only available when a sequence is activated.</p> <p> (hide) or  (show).</p> <ul style="list-style-type: none"> <li>&gt;</li> </ul>
Deactivate sequence / end recording	<p>Function is only available when a sequence is activated or when a recording is ongoing.</p> <p> .</p> <ul style="list-style-type: none"> <li>&gt;</li> </ul>

## Image stitching

The image stitching wizard can be used to produce a large panoramic image from up to 3x 3 single images. The wizard helps when recording the single images and ensures that there is sufficient overlap for stitching together to create a panoramic image using the PC software.

Before calling up the function, please note:

When the function is called up, the scale is set to manual and the temperature scope at this time is fixed. This temperature scope may not be sufficient for the entire panoramic image.

Recommendation:

- > Scan the entire object for the panoramic image to determine the required temperature scope (minimum/maximum measurement value). Set scale to manual and set scale limits, see Scale manual, page 50.



If the **SuperResolution** function is activated, it is deactivated when the image stitching wizard is called up. When the image stitching wizard is ended, **SuperResolution** is activated again.







When recording single images, please note:



When capturing single images, please note:





- > Rotate the camera with your wrist. Do not move it horizontally. Ideally, use a tripod.

Task	Actions/description
Call up function.	>       <b>Wizards</b>   <b>Image stitching</b> .
Record single images.	<ol style="list-style-type: none"> <li>1. Record single image 1 (top left): <b>[Trigger button]</b>.</li> <li>2. Rotate the camera to the right until the image is cleanly joined to the semi-transparent image strip of individual image 1.</li> <li>3. Record single image 2 (top centre): <b>[Trigger button]</b>.</li> <li>4. Carry out the steps accordingly for the other single images.</li> </ol> <p>Depending on the single images already recorded, fixed parts of the image are shown in the left or top half of the image. The current image must</p>

	<p>be joined accordingly to the image on the left or above.</p> <hr/> <p><b>i</b> When carrying out alignment to determine where the next single image must be joined, the single image overview helps, see below.</p> <hr/> <p>To record the single images in another order, see single image overview (below).</p>
<p>Display single image overview and select single image to delete/replace it.</p>	<p>1.  .</p> <ul style="list-style-type: none"> <li>- The single image overview is displayed.</li> </ul> <p>For a realistic display of the panoramic image, a projection on a semi-circular surface is required. As the image is displayed on one plane, it is distorted around the edges.</p> <p>2. Select single image: Touch single image. Images not available for selection are indicated with a "X".</p> <ul style="list-style-type: none"> <li>&gt; Delete selected single image:  .</li> <li>&gt; Replace selected single image: Close single image overview and record single image again.</li> <li>&gt; Close single image overview:  .</li> </ul>
<p>Save panoramic image.</p>	<p>&gt;  .</p>
<p>Select where to save image.</p>	<p>&gt;  .</p> <ul style="list-style-type: none"> <li>- The <b>Folder</b> input screen is opened.</li> </ul>
<p>Close image stitching wizard.</p>	<p>1.  .</p> <p>2. Acknowledge confirmation prompt.</p>

## SiteRecognition

With the PC software, markers can be set to clearly indicate a measuring site. By setting a marker with the built-in digital imager, the images, which are then saved, are automatically allocated to the relevant site (allocation is saved with this image). For the creation of markers, transferring of measuring site data to the imager and copying of images to the PC software, see instruction manual for the PC software.

Task	Actions/description
Call up function.	<p>&gt;       <b>Wizards</b>   <b>SiteRecognition</b>.</p> <ul style="list-style-type: none"> <li>- The real image is displayed and a position frame is shown.</li> </ul> <p>Once the function has been called up via the menu (see above) and at least one marker has been set, the function can also be called up via the main menu tab.</p> <p>&gt;    .</p> <p>When the imager is switched off, the entry is removed again from the tab.</p>
Enter measuring site marker.	<ol style="list-style-type: none"> <li>1. Position the imager so that the marker is inside the position frame.</li> <li>2. After recognition of the marker ID: confirm transfer of measuring site data.</li> </ol>

## FeverDetection

Generally, the grey palette is automatically activated in the **FeverDetection** menu. There is also a range selection visible in the centre of the live thermal image. The hotspot is automatically shown within this range selection.

Generally, the grey palette is automatically activated in the **FeverDetection** menu. There is also a range selection visible in the centre of the live thermal image. The hotspot is automatically shown within this range selection.

The **FeverDetection** assistant detects a person's warmest point and compares it with a progressive mean value of previous persons.

In the event of a deviation (the deviation difference can be manually adjusted under the Tolerance menu item) from this mean value, the thermal imager triggers an acoustic and visual alarm. The progressive mean value can be calculated in two different modes:



**Manual mode**

The person's reading is included in the mean value once this has been confirmed manually by pressing a button.



**Automatic mode**

The thermal imager detects a person via the built-in facial recognition. As soon as the thermal imager has detected the person, the reading is determined and included in the mean value calculation.









The thermal imager's recorded temperatures are lower than the person's true body temperature, since the thermal imager can only measure the temperatures on the surface.



The thermal imager cannot be used to diagnose fever. It compares the surface temperature of different people and gives an indication as to whether a person may have an elevated body temperature.

The **FeverDetection** menu includes the following submenu items:

*Scale manual*







Scale manual is used for manual adjustment of the scale. This makes the temperature differences more clearly visible. When you open the assistant, the scale is generally set to automatic.

Task	Actions/description
Call up function.	>       <b>Assistants</b>   <b>FeverDetection.</b>
Open <b>Scale manual</b> input screen.	Touch  .
Activate/deactivate manual scale adjustment.	>  <b>Active.</b> > To deactivate, touch the button again.
Set scale limits.	>  ,  .

Task	Actions/description
Link setting for upper/lower limits.	>  .
Apply entries.	>  .

### *Emissivity + RTC*

With Emissivity + RTC, these two parameters can be set manually. However, emissivity is automatically set to 0.98 as soon as the **FeverDetection** assistant is activated (when you quit, the previous emissivity setting is adopted again).

Task	Actions/description
Call up function.	>       <b>Assistants</b>   <b>FeverDetection.</b>
Open <b>Emissivity</b> input screen.	Touch  .
Set emissivity and reflected temperature ( <b>RTC</b> ) manually.	>  ,  .
Apply entries.	>  .



### *Alarm value*









In the Alarm value setting, you can set the temperature from which a person may have an elevated body temperature, and from which the thermal imager should trigger the acoustic and visual alarm.

Mean value: When launching the FeverDetection assistant, enter the determined average temperature of multiple “healthy” people. This input mean value is then progressively overwritten via the manual or automatic mode of the FeverDetection assistant.

Tolerance: Enter the difference by which the alarm value is to exceed the mean value.

Mean value + tolerance therefore produces the alarm value, from when the thermal imager triggers an acoustic and visual alarm.

Task	Actions/description
Call up function.	>       <b>Assistants</b>   <b>Panorama image.</b>

Task	Actions/description
Open <b>Alarm</b> input screen.	
Activate/deactivate alarm value	>  <b>Active</b> . > To deactivate, touch the button again.
Activate/deactivate acoustic alarm	>  <b>Active</b> . > To deactivate, touch the button again.
Set alarm values - mean value	>  , 
Set alarm values - tolerance	>  , 
Apply entries.	> 

End **FeverDetection** assistant

End **FeverDetection**: the assistant is closed and the normal thermal image is displayed again. All the settings which had been activated before the **FeverDetection** assistant are shown again.

Task	Actions/description
End <b>FeverDetection</b> assistant	Touch 

*Recording (freezing/saving) an image*

Thermal images can be created and saved in the **FeverDetection** assistant.

1. Press the **[Trigger]**.
  - The image is frozen (still).
2. Save image: Press the **[Trigger]** again.
  - The grey palette appears in the stored thermal image with the alarm. The range selection is no longer displayed with the stored image, but it can be reactivated in the stored image at a later stage.  
The same applies to the hotspot in the range selection.



**i** The person being examined must not be wearing glasses. The warmest spot on the surface of a person's body is the lacrimal gland in the eyes.

**i** **FeverDetection** using the thermal imager is not a medically precise measurement.





**i** The **FeverDetection** alarm is not displayed in IRSoft.

**i** The **FeverDetection** wizard should only be used with the standard or 25 ° lens.

## 6.2.5. Configuration

### Country settings

Instrument language and temperature unit can be set.

Task	Actions/description
Open <b>Country settings</b> input screen.	>       <b>Configuration</b>   <b>Country settings</b> .
Set the language of the program interface.	> Highlight the language to be used by touching on it.
Change temperature unit.	>  - The activated unit is shown on the top right of the display.
Apply entries.	>  .

### Super-resolution (optional)

SuperResolution is a technology to improve image quality. Each time an image is recorded, a sequence of images is saved on the thermal imager and used to calculate a higher-resolution image with the aid of the PC software (no interpolation). The pixel count increases by a factor of 4, while the geometric resolution (IFOV) is improved by a factor of 1.6.

To use the function, the imager must be hand-held (no tripod).

**i** This function is available as an additional option (article no. 0554 7806) and must be activated before it can be used, if the option was not ordered at the same time as the imager.

Activate function (only with subsequent order):

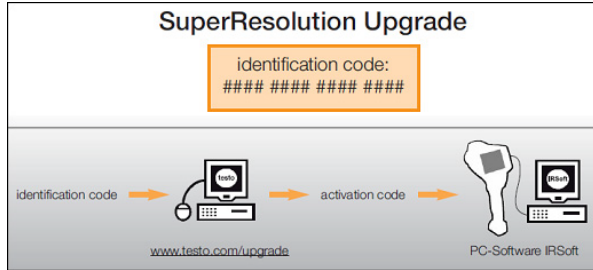



You will receive an envelope with an access code (identification code), which you should enter on the website [www.testo.com/upgrade](http://www.testo.com/upgrade).

When all necessary data has been entered, an activation code is generated and can be used to activate the function via the IRSOFT PC software. Please observe the installation requirements and steps on the website or in the email sent to you.

To use the function, the following conditions must be fulfilled:





- The imager is hand-held (no tripod).
- The objects to be imaged do not move.

Task	Actions/description
Activate/deactivate function.	<p data-bbox="588 986 935 1069">&gt;       <b>Configuration</b>   <b>SuperResolution.</b></p> <p data-bbox="599 1093 1002 1204"><b>i</b> If the function is activated, when an image is frozen, <b>(SR)</b> is displayed additionally behind the <b>Save Image?</b> box.</p>

### Save JPEG





Infrared images are saved in BMT (image with all temperature data) format. The image can also be saved in JPEG format (without temperature data) at the same time. The image content corresponds to the infrared image shown on the display, including scale display and image marks for the selected measuring functions. Date and time the photo was taken can be displayed in

the image. The JPEG file is saved under the same file name as the associated BMT file and can be opened on the PC, even without using the IRSoft PC software.

Task	Actions/description
Disable/enable <b>Save JPEG</b> function.	      <b>Configuration</b>   <b>JPEG</b> . 1. 2. Select <b>Save JPEG</b> function by touching (☑). > To disable, repeat these steps.
Disable/enable <b>Show date/time</b> function ( <b>Save JPEG</b> function must be enabled).	      <b>Configuration</b>   <b>JPEG</b> . 1. 2. Select <b>Show date/time</b> function by touching (☑). > To disable, repeat these steps.

## HDMI

The HDMI menu can be used to connect the camera to a computer. Once the instruments are connected, the camera's display data is shown on the computer screen. Operation is via the camera joystick.





Task	Actions/description
Open the <b>HDMI</b> input screen.	      <b>Configuration</b>   <b>HDMI</b> . >
 Activate/deactivate HDMI connection.	 <b>Active</b> . > To deactivate, touch the button again.

## Bluetooth

This function is not available in all countries.

Via the Bluetooth radio interface, a link to a Bluetooth headset can be established for voice recording. Follow the instruction manual for the Bluetooth headset.

Task	Actions/description
Open <b>Bluetooth</b> input screen.	      <b>Configuration</b>   <b>Bluetooth</b> . >

Task	Actions/description
De-/activate Bluetooth radio link.	<p>&gt;  <b>Active.</b></p> <p>&gt; To deactivate, touch the button again.</p>
Search for Bluetooth devices and establish link.	<p>1. .</p> <p>- A search is carried out for Bluetooth devices (with enabled pairing mode) and available devices are displayed.</p> <p>2. Establish link to Bluetooth device: select device by touching it ().</p>
Apply entries.	<p>&gt; .</p>

## Radio

This function is not available in all countries.





A radio humidity probe can be logged onto the instrument.

Every radio probe has a probe identification number (RFID). This is made up of the three-digit RFID number on the probe and the position of the switch in the battery compartment of the radio probe (**H** or **L**). To be logged on at the instrument, the radio probe must be switched on and the transfer rate must be set to 0.5 s. This is done by briefly pressing the on/off button when switching on (also see instructions for use of radio probe).

If no radio probe is found, this may be because of the following:



- The radio probe is not switched on or the radio probe battery is dead.
  - The radio probe is outside the radio range.
  - Sources of interference influence radio transmission (e.g. reinforced concrete, metal objects, walls or other barriers between the transmitter and receiver, other transmitters of the same frequency and strong electromagnetic fields).
- > If necessary: Rectify the possible causes of the fault in radio transmission.

Task	Actions/description
Open <b>Radio</b> input screen.	<p>&gt;       <b>Configuration</b>   <b>Radio.</b></p>

Task	Actions/description
Activate/deactivate radio and establish connection to a radio humidity probe.	<ol style="list-style-type: none"> <li>  <b>Active.</b> <ul style="list-style-type: none"> <li>A search is carried out for radio probes and available radio probes are displayed.</li> </ul> </li> <li>Highlight the radio probe to be used by touching it ().</li> </ol> <p>&gt; To deactivate, touch the button  again.</p>
Apply entries.	>  .

### Configure key

The assignment of the shortcut keys can be changed.







Task	Actions/description
Open <b>Configure key</b> input screen.	>       <b>Configuration</b>   <b>Configure key.</b>
Activate button function.	<p>&gt; Highlight the function to be used by touching on it.</p> <p>The following functions can only be activated via the shortcut keys:</p> <ul style="list-style-type: none"> <li><b>Light:</b> switch on/off power LEDs for lighting up objects for the digital imager.</li> <li><b>Laser:</b> switch on laser marker for marking the measuring surface. Operating information: the shortcut button must be held down to activate the laser. When the laser is activated, an extra cursor is displayed. This marks the precise point at which the laser appears on the object.</li> <li><b>Adjustment:</b> Carry out adjustment.</li> </ul>
Apply entries.	>  .

### Optics

The lenses adjusted to the instrument are shown. Only the lenses that are shown may be used. Lens activation is automatic (not in USA).







The **Protection glass** option can be used to set whether protection glass is fitted. Ensure the correct setting to prevent corruption of the measurement results.







**i** It is not possible to use IR protection glass in conjunction with a super-telephoto lens.

Task	Actions/description
Open <b>Optics</b> input screen.	>       <b>Configuration</b>   <b>Optics.</b>
Manually activate fitted lens (only required in USA).	> Highlight the lens to be used by touching on it.
Activate/deactivate protection glass option.	>  <b>Protection glass.</b> > To deactivate, touch the button again. - When the option is activated, the protection glass symbol (  ) is displayed top right. > To deactivate, touch the button  again.
Apply entries.	>  .

### Power-save options







The options affecting battery life can be set.

Task	Actions/description
Open <b>Power-save options</b> input screen.	>       <b>Configuration</b>   <b>Power-save options.</b>
Set the brightness of the <b>LCD backlight:</b>	>     (low) or  (medium) or  (high).

Task	Actions/description
Activate/deactivate automatic switch-off function <b>LCD off</b> or <b>Imager off</b> and set the switch-off time.	<ol style="list-style-type: none"> <li> <b>Active.</b></li> <li>    ,    .</li> </ol> <p>&gt; To deactivate, touch the button  again.</p>
Apply entries.	>  .

### Set time/date



Time and date can be set. The time and date format are set automatically based on the selected instrument language.

Task	Actions/description
Open <b>Set time/date</b> input screen.	>       <b>Configuration</b>   <b>Set time/date.</b>
Set time or date values.	<p>&gt; .</p> <p>&gt;  , .</p> <p>&gt; .</p>
Apply entries.	>  .

### Reset counter



Please note: After a reset, the consecutive numbering of images starts again from the beginning. When saving images in the same folder, already saved images with the same number are overwritten!

> Back up all saved images before performing a reset to prevent possible overwriting.

Task	Actions/description
Execute function.	<ol style="list-style-type: none"> <li>      <b>Configuration</b>   <b>Reset counter.</b></li> <li>Confirm reset: .</li> </ol>

**Delete all**



The data on the memory card can be deleted.

Task	Actions/description
Execute function.	<ol style="list-style-type: none"> <li>      <b>Configuration</b>   <b>Delete all</b>.</li> <li>Confirm deletion: .</li> </ol>

**Format**

The memory card can be formatted.



Please note: During formatting, all saved data on the inserted memory card is lost.

Task	Actions/description
Execute function.	<ol style="list-style-type: none"> <li>      <b>Configuration</b>   <b>Format</b>.</li> <li>Confirm format: .</li> </ol>

**Factory settings**

The instrument settings can be reset to the factory settings.

Please note: time/date, country settings and counter are not reset.

Task	Actions/description
Execute function.	<ol style="list-style-type: none"> <li>      <b>Configuration</b>   <b>Factory settings</b>.</li> <li>Confirm reset: .</li> </ol>

**6.2.6. Audio**













To use the function, a headset must be connected (top interface terminal) or the link to a Bluetooth headset must be established.

This function is only available with the view of a frozen or saved image. For these images, voice commentary can be recorded and edited.

Next to the bar display (top), two times are displayed (format mm:ss):



- Left time: current recording or playback time (corresponds to right end of the white recording or playback bar).
- Right time: maximum recording period (60 s).

Task	Actions/description
Open <b>Audio</b> input screen.	<p>&gt;    .</p> <p>or</p> <p>&gt;       <b>Audio</b>.</p>
Play back recording.	<p>&gt; .</p> <ul style="list-style-type: none"> <li>- The recorded voice commentary is played back from the current playback time.</li> </ul>
Start recording/resume recording.	<p>&gt; .</p> <ul style="list-style-type: none"> <li>- Recording is started or resumed from the current recording time.</li> </ul>
Stop recording/jump to time 00:00.	<p>&gt; .</p> <ul style="list-style-type: none"> <li>- During recording: recording is stopped.</li> <li>- When recording is stopped: recording or playback time is set to 00:00.</li> </ul>
Delete recording.	<p>&gt; .</p>
Set playback volume (only for wired headset).	<p>1. .</p> <p>2.  (loud) or  (normal) or  (quiet).</p>
Apply entries.	<p>&gt; .</p>

## 6.3. Measuring

### Important framework conditions

Please observe the following framework conditions in order to obtain significant measurement results.

Humidity measurement:

- Pivot the separate humidity measuring instrument or optional radio humidity probe slightly to shorten the adjustment time. Avoid sources of interference (e.g. exhaled air).

Building thermography, investigating the building shell:

- Considerable temperature difference between inside and outside required (ideal:  $>15^{\circ}\text{C}$  /  $>27^{\circ}\text{F}$ ).
- Consistent weather conditions, no intensive sunlight, no precipitation, no strong wind.

To ensure maximum accuracy, the imager requires an adjustment time of 10 minutes after it is switched on.



When using the super-telephoto lens, if there is a change in the ambient conditions the camera may require an adjustment time of  $> 10$  min.

---

### Important settings

Before recording an image, check whether the protection glass option is set correctly to prevent corruption of the measurement results, see Optics, page 70.

Before saving an image, make sure that it is correctly focussed, manually (see Manually focusing the image, page 35) or automatically (see Automatically focusing the image, page 36). Images that are not in focus cannot be corrected retroactively!

To obtain precise measurement values, the emissivity and reflected temperature must be set correctly, see Emissivity, page 48.

Subsequent adjustment is possible via the PC software, if required.

When humidity is high or the imager is a considerable distance from the object to be measured, atmospheric correction increases measurement accuracy, see Atmospheric correction, page 47.

When auto-scaling is activated, the colour scale is continuously adjusted to the min.-/max.- values of the current measurement image. This means that the colour assigned to a specific temperature is changing constantly! To be able to compare multiple images based on the assigned colour, scaling must be set manually to fixed values (see Scale manual, page 50), or must be subsequently adjusted to uniform values using the PC software.

## 7 Maintaining the product

### Changing the rechargeable battery

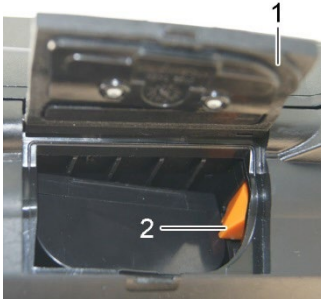

1. Open battery compartment cover (1).
2. Press red lock release button (2).
  - The rechargeable battery is released and sticks out a little from the battery compartment.
3. Pull the rechargeable battery out of the battery compartment.
4. Slide rechargeable battery fully into the battery compartment until it clicks into place.
  - The imager starts automatically.
5. Close the battery compartment cover.

### Cleaning the display

- > Clean the display when dirty with a cleaning cloth (e.g. microfibre cloth).

### Clean thermal imager

- > If the housing of the thermal imager is dirty, clean it with a damp cloth. Do not use any aggressive cleaning agents or solvents! Weak household cleaning agents and soap suds may be used.

### Cleaning lens protection glass

- > Large dust particles can be removed with a clean optical cleaning brush (available in specialized photography shops).
- > Use a lens cleaning cloth for slight contamination. Do not use rubbing alcohol!

## 8 Tips and assistance

### 8.1. Questions and answers

Question	Possible causes / solution
Error <b>No memory card inserted!</b> is displayed.	Memory card defective or not inserted. > Check or insert memory card.
Error <b>Memory card full!</b> is displayed.	Insufficient memory present. > Insert new memory card.
Error <b>No lens</b> or <b>Wrong lens!</b> is displayed.	> Check lens > Change lens if necessary.
Information <b>Charging not possible</b> is displayed.	Ambient temperature is outside the permissible range for charging the battery. > Observe permissible ambient temperature.
Error <b>Permissible instrument temperature exceeded! Turn off instrument!</b> is displayed.	1. Switch off thermal imager. 2. Allow instrument to cool down and observe the permissible ambient temperature.
~ is displayed before a value.	Value is outside the measuring range: extended display range with no guarantee of accuracy.
--- or +++ is displayed instead of a value.	Value is outside the measuring range and the extended display range. > Change measurement range.
xxx is displayed instead of a value.	Value cannot be calculated. > Check parameter settings for plausibility.

If we were unable to answer your question, please contact your local dealer or Testo's Customer Service. Refer to the back of this document or website [www.testo.com/service-contact](http://www.testo.com/service-contact) for contact details

## 8.2. Accessories and spare parts

Description	Article no.
Lens protection glass	0554 0289
Additional battery	0554 8852
Fast battery charger	0554 8851
Adhesive emission tape	0554 0051
Process analysis function, image sequence capturing in the instrument and fully radiometric video measurement	0554 8902
SuperResolution function	0554 7806
ISO calibration certificates:	
Calibration points at 0°C, 25°C, 50°C	0520 0489
Calibration points at 0°C, 100°C, 200°C	0520 0490
Freely selectable calibration points in the range 18°C to 250°C	0520 0495
Retrofitting for high temperature	on request from Testo Service
Telephoto lens	on request from Testo Service
Super-telephoto lens	on request from Testo Service
25° lens	on request from Testo Service
Self-adhesive labels for creating markers for site recognition	available from specialist office supplies stockists. Recommendation: Avery Zweckform L4776

For further accessories and spare parts, please refer to the product catalogues and brochures or look up under [www.testo.com](http://www.testo.com)



**Testo SE & Co. KGaA**

Celsiusstr. 2

79822 Titisee-Neustadt

Germany

Tel.: +49 7653 681-0

E-Mail: [info@testo.de](mailto:info@testo.de)

[www.testo.com](http://www.testo.com)